



TECHNICAL SHEET

Society of Polystyrene Products Industries

SIPP

Rolling Shutter Box 35



Description

The SIPP roller shutter box is a box prefabricated in EPS expanded polystyrene which will be anchored to the concrete lintel. The trunk body is composed of :

- A reinforced expanded polystyrene shell,
- A welded mesh reinforcement,
- Two aluminum profiles serving as a coating stopper finishing on the outside of the shell and support for the underside,
- One-piece side panels to clip on at both ends of the trunk which will be used to receive the shutter axis supports rollers and fix the underside.

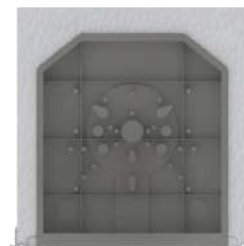
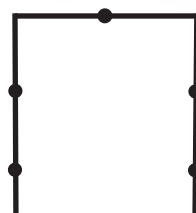

Area of use

The trunk can be equipped with all types of roller shutters thanks to with adaptable side panels. It is a prefabricated chest which will be perfectly anchored to the lintel with a raised surface for better adhesion of the coating.

Technical Characteristics

WELDED MESH

- Link (central): 350/185 mm
- Link (lateral): 350/125 mm
- Section of longitudinal steels: Ø5 mm
- Section of transverse steels: Ø4 mm

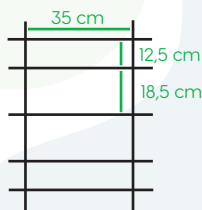

POLYSTYRENE SHELL

- Average density: 35
- Thickness of side walls: 35 mm
- Top wall thickness: 50 mm
- Hull width: 350 mm
- Hull height: 350 mm

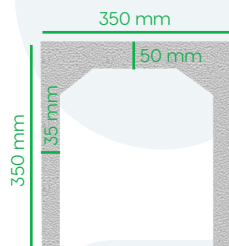

ALUMINUM PROFILE

- Thickness: 1.1mm
- Coating stop width: 10mm with 1mm return
- Depth of Support under face: 10 mm



MONOBLOCK CHEEKS

- Materials: Injected plastic under pressure
- Equipment: Two clips for hanging in the hull in polystyrene
- A tab to ensure fixing the underside

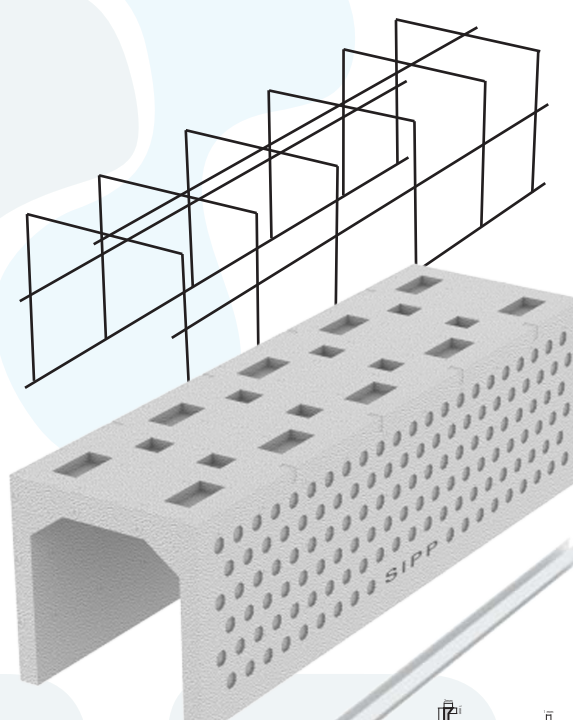
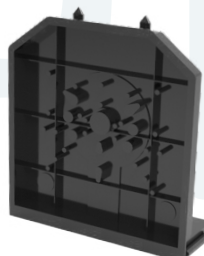
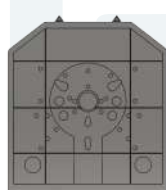

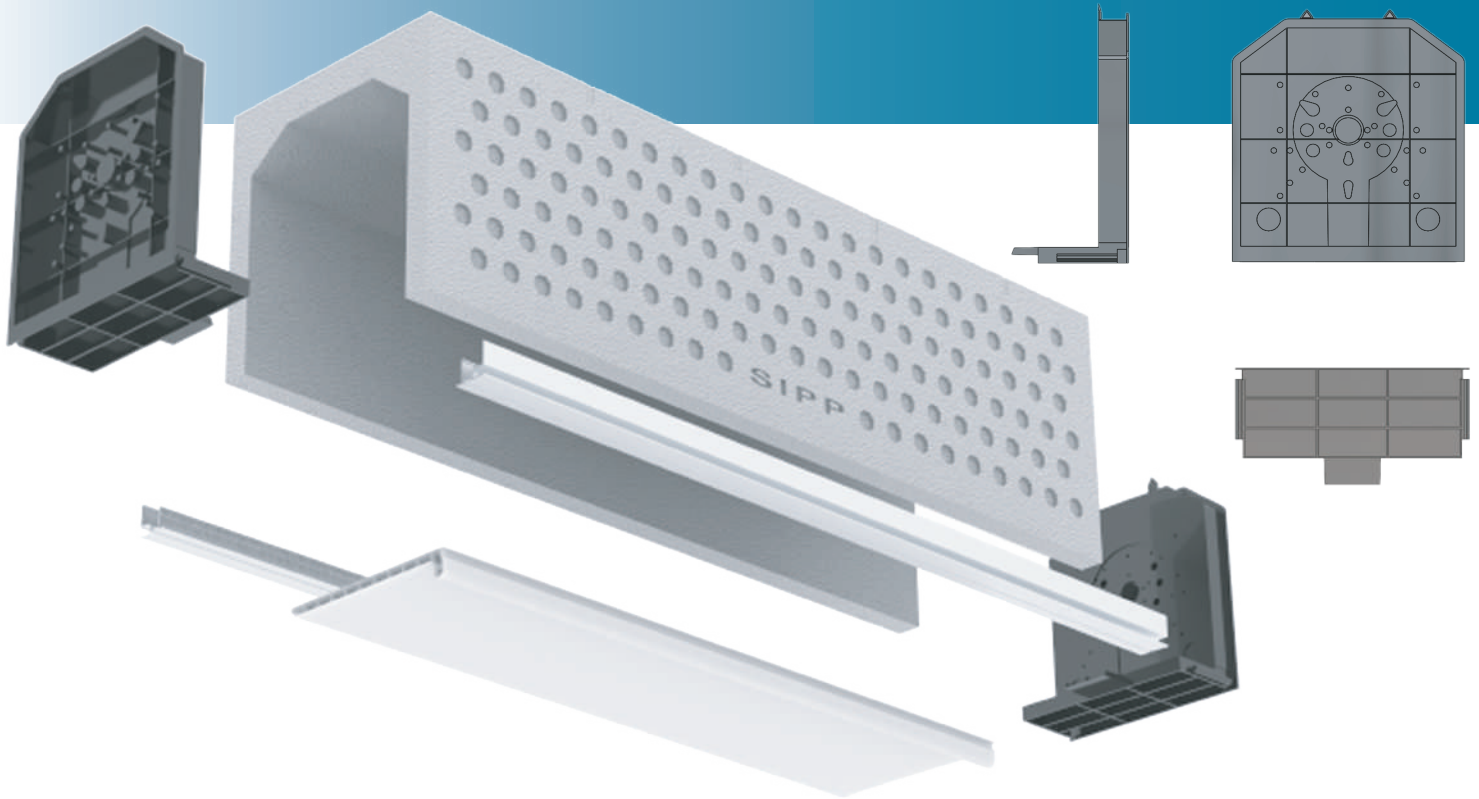

The different dimensions of roller shutter boxes

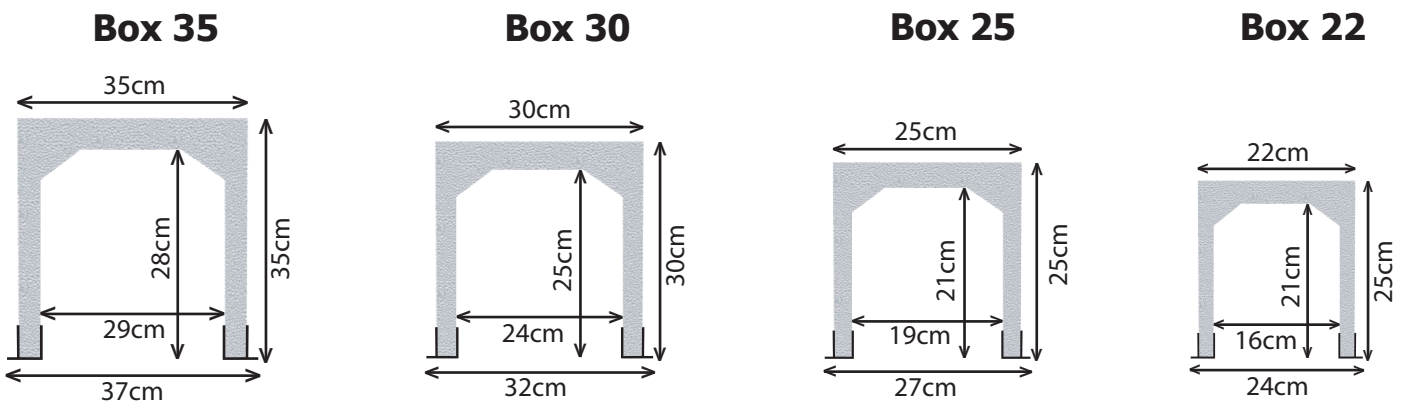

The correspondence matrix

		CVR 22		CVR 25		CVR 30		CVR 35	
LAME 45	AXE40	1.80	METRE L	2	METRE L	2.40	METRE L	-	METRE L
		40	PIECES	45	PIECES	53	PIECES	-	PIECES
	AXE60	1.60	METRE L	1.80	METRE L	2.20	METRE L	3.10	METRE L
		36	PIECES	40	PIECES	49	PIECES	68	PIECES
	AXE70	-	METRE L	1.60	METRE L	2	METRE L	3	METRE L
		-	PIECES	36	PIECES	45	PIECES	66	PIECES
AXE80	-	METRE L	-	METRE L	1.8	METRE L	2.8	METRE L	
	-	PIECES	-	PIECES	40	PIECES	62	PIECES	
LAME 55 (EXTRUDE)	AXE40	-	METRE L	-	METRE L	-	METRE L	-	METRE L
		-	PIECES	-	PIECES	-	PIECES	-	PIECES
	AXE60	-	METRE L	1.20	METRE L	2.39	METRE L	3	METRE L
		-	PIECES	22	PIECES	46	PIECES	55	PIECES
	AXE70	-	METRE L	1.10	METRE L	2.37	METRE L	2.8	METRE L
		-	PIECES	20	PIECES	44	PIECES	51	PIECES
	AXE80	-	METRE L	1	METRE L	2.35	METRE L	2.6	METRE L
		-	PIECES	18	PIECES	42	PIECES	47	PIECES

